

ON TARGET

LEADER NOTES

The Challenge

Modify a paper cup so it can zip down a line and drop a marble onto a target.

In this challenge, kids follow the engineering design process to: (1) modify a cup to carry a marble down a zip line; (2) attach a string to tip the cup; (3) test their cup by sliding it down the zip line, releasing the marble, and trying to hit a target on the floor; and (4) improve their system based on testing results.

1 Prepare ahead of time

- Read the challenge sheet and leader notes to become familiar with the activity.
- Gather the materials listed on the challenge sheet.
- Set up a sample zip line.
- Put a handle and paper clip on a cup (In other words, don't make a door or platform for the marble.)
- Optional: print a picture of the Lunar Crater Observation and Sensing Satellite (LCROSS) from the LCROSS Web site (lcross.arc.nasa.gov).

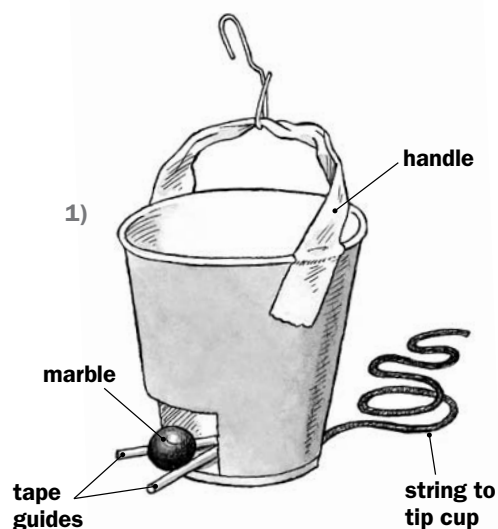

2 Introduce the challenge (5 minutes)

- **Tell kids how NASA will use the LCROSS spacecraft to search for water on the moon.**
To see if there's water on the moon, NASA is sending the Lunar Crater Observation and Sensing Satellite (LCROSS) hurtling into a crater near the moon's South Pole. The collision will send up a plume of dust and gas over 6 miles (10 km) high. Scientists will study this plume to see if there are any signs of water in it.
- **Show kids your zip line. Hang the cup on the zip line, using a hook made of a paper clip. Show kids how the cup travels down the zip line. Tell them:**

Today you'll turn a paper cup into something that can zip down a line and drop a marble onto a target. Just as the success of LCROSS depends on hitting the crater exactly, success in today's activity depends on being able to hit the target accurately and consistently. As you test your design, you'll find ways to make it work better. Improving a design based on testing is called the engineering design process.

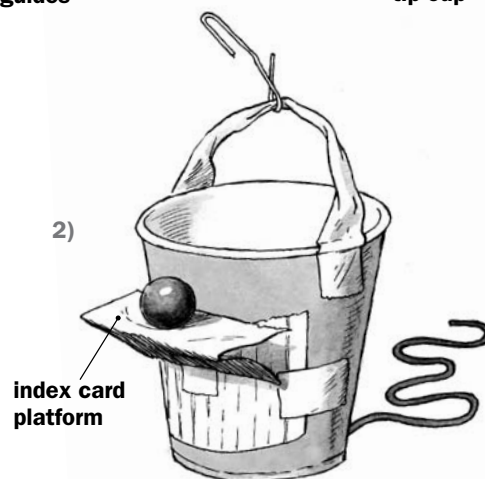

Sample marble carriers showing parts and two possible solutions: 1) an opening; 2) a platform

3 Brainstorm and design (10 minutes)

Distribute the challenge sheet. Discuss the questions in the Brainstorm and Design section.

- **How will you modify the cup so it can carry a marble down a zip line and also drop it onto a target?** (If the marble rides inside the cup, kids need to cut a door. If it rides outside the cup, kids need to make a platform, shelf, or holder. All systems need a way to tip the cup at the right instant.)
- **How will you remotely release the marble from the cup?** (Attaching a string on the uphill side of the cup, opposite the door or platform, will enable kids to tip the cup effectively.)
- **When do you need to launch the marble so that it will hit the target?** (Kids should stand near the top of the zip line, holding one end of the string. When the cup reaches the “drop zone,” kids should jerk the string. The marble will be ejected and fall toward the target. NOTE: When dropped, the marble keeps moving forward as it falls. Kids will need to factor in this forward motion as they decide when to release the marble.)

4 Build, test, evaluate, and redesign (35 minutes)

Help kids with any of the following issues. For example, if:

- **the cup goes slowly down the zip line**—Make sure the cup slides freely. Also, check the steepness of the zip line.
- **the remote release line is too short**—Kids should estimate where the “drop zone” on the zip line is and make the remote release line at least that long.
- **the marble doesn't eject cleanly**—Enlarge the opening or unblock the platform. Also place small rolls of tape in the bottom of the cup to guide the marble toward the opening.
- **the marble accidentally falls out of the cup or off the platform**—Adjust the tilt of the cup, if necessary. Also, kids can roll small tubes of tape to hold back the marble.
- **the marble misses the target**—Check that the door or platform doesn't interfere with the marble. Also, make sure kids are releasing the marble before the cup is above the target.

5 Discuss what happened (10 minutes)

Have kids show each other their modified cups and talk about how they solved any problems that came up. Emphasize the key ideas in today's challenge by asking:

- **What parts of your design were most important in getting the marble to hit the target?** (Getting the marble to eject cleanly from the cup and the timing of release are important.)
- **After testing, what changes did you make to your cup?** (Answers will vary.)
- **Describe the way your marble moved after you ejected it.** (It moved both downward and forward. This combination produced a curved path called a trajectory.)
- **Newton's First Law states that an object in motion continues in straight-line motion until acted on by a force. How did today's activity demonstrate Newton's First Law?** (As it traveled down the zip line, the marble built up speed. Once launched, it kept going at that speed until a force, such as gravity pulling it down or the floor stopping it, acted on the marble.)
- **How is your challenge similar to NASA's LCROSS mission to the moon?** (Both you and NASA devised a system that caused something to crash into a surface. Also, both setups have a remote triggering device, although LCROSS's is radio controlled. Finally, both the marble and the spacecraft have a forward and downward component to their motion.)

EXTEND THE CHALLENGE

- **Watch a video about LCROSS.** The LCROSS Web site has a four minute-long video that describes the mission and uses animation to show what happens when LCROSS strikes the moon's surface. Watch it online at: lcross.arc.nasa.gov.
- **Analyze an object's motion as it follows a trajectory.** To show that an object's speed is constant as it follows a trajectory (a curved path), take a video of the marble falling from the cup. Play it back on a TV or computer one frame at a time. Tape a transparency to the TV or computer screen, and make marks from frame to frame, measuring the horizontal distance traveled by the marble each time. Kids will see that the distance traveled in each frame is constant. Alternatively, have your kids try the Projectile Motion interactive at www.teachersdomain.org. Type "projectile motion" into the Teachers' Domain 'search' box.

CURRICULUM CONNECTIONS

On Target ties to the following concepts commonly covered in science, math, and technology curricula. For a list of education standards supported by the activity, see pages 41 and 42.

- **Newton's First Law**—As it travels down the zip line, the marble builds up a forward speed. Once launched, it will keep going at that speed until a force acts on it, such as hitting the ground.
- **Acceleration**—Due to Earth's gravitational pull, the marble's speed increases as it falls.
- **Vectors**—The marble's motion has both a horizontal and a vertical component, and these motions can be represented in a vector diagram.
- **Trajectory**—When an object that's already moving horizontally is dropped (like a marble dropped from a cup moving down a zip line), it travels in a curved path, called a trajectory.
- **Potential and kinetic energy**—The marble's stored (potential) energy changes to motion (kinetic) energy as it falls.
- **Measurement**—Kids measure to make the zip line. They also measure the height from which their marble is dropped and how far it lands from the target.

A NASA/DESIGN SQUAD CHALLENGE

ON TARGET

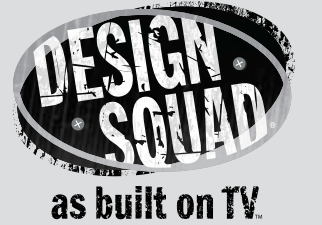
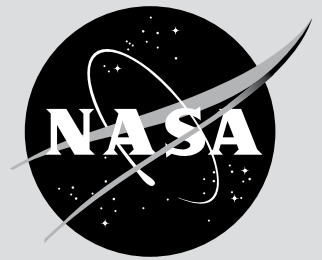

Thanks to NASA, the moon is getting a new crater! NASA is sending a spacecraft hurtling into the moon's surface. Why? To see if there's water below the surface. This collision will send up a plume of dust and gas over 6 miles (10 km) high. To tell if there's any water, scientists will look for ice crystals and water vapor in this plume.

WE CHALLENGE YOU TO...

...modify a paper cup so it can zip down a line and drop a marble onto a target.

BRAINSTORM AND DESIGN

Think about how you might design a way to carry and launch a marble:

- How will you modify the cup so it can carry a marble down a zip line and also drop it onto a target?
- How will you remotely release the marble from the cup?
- When do you need to launch the marble so that it will hit the target?

BUILD

- 1. First, set up a zip line.** Tie 6 feet (1.8 m) of the smooth line to two objects (e.g., two chairs or a table and chair). Make sure it's stretched tight and that one end is about 20 inches (50 cm) below the other.
- 2. Next, figure out how to modify the cup to carry the marble down the zip line.** Will it travel inside the cup? Outside the cup on a platform? Underneath?
- 3. Then, add a remote release.** Decide how you will tip the cup at just the right instant to launch the marble toward the target.
- 4. Finally, clip the cup to the zip line.** Figure out how to hook the cup onto the zip line so it slides easily.

MATERIALS (per zip line)

- 9 feet (3m) of smooth line (e.g., fishing line or kite string)
- index card
- marble
- masking tape
- paper clip
- 1 medium-sized paper cup
- scissors
- target drawn on a piece of paper

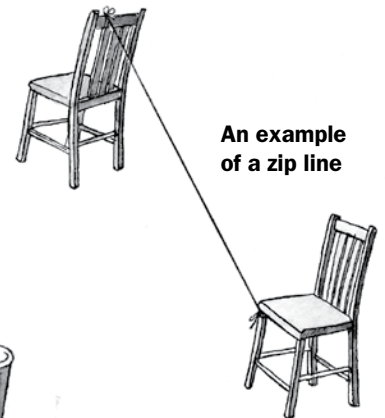

TEST, EVALUATE, AND REDESIGN

Ready for a test run? Place the target near the end of the zip line. Send down the cup and try to hit the target with the marble, using the remote release. How close did you get? See a way to improve your design? Engineers improve their designs by testing them. The steps they follow are called the design process. Try your idea and build an improved version. For example, if your cup:

- **goes slowly**—Check that the zip line is steep enough. Also, make sure the cup slides freely.



Materials to make a zip line, carrier, and target

- **can't keep the marble in**—Roll a small tube of tape to keep the marble from falling out accidentally. Also, adjust the tilt of the cup so it doesn't tip the marble out.
- **doesn't let the marble out**—Roll small tubes of tape and build a chute to funnel the marble toward the opening. If necessary, adjust the tilt of the cup so the marble can roll out more easily.
- **misses the target**—Since the marble is already moving forward along the zip line, it keeps moving forward as it falls. Make sure to take this forward motion into account as you choose a release point.

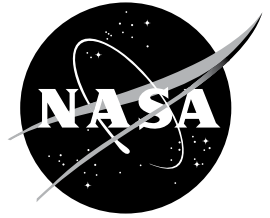

Check out NASA's moon missions at moon.msfc.nasa.gov.

“RUNNING AROUND IN THE WOODS HELPED ME THE MOST.”



As a kid, Tony Colaprete loved nature, ecology, and running around in the woods. He liked thinking about how, in one way or another, everything is connected. He brings that kind of thinking to his job as a

planetary scientist and as the top scientist for NASA's LCROSS mission. To learn about how other planets work, he builds computer models and designs instruments. These help him understand the many interesting connections between the different planets in our solar system. And the more Tony discovers, the more we learn about how our world—Earth—fits within our solar system.

NASA's Lunar Crater Observation and Sensing Satellite (LCROSS) will hit the moon, raising a tall plume of dust and gas and hopefully revealing the presence of water.

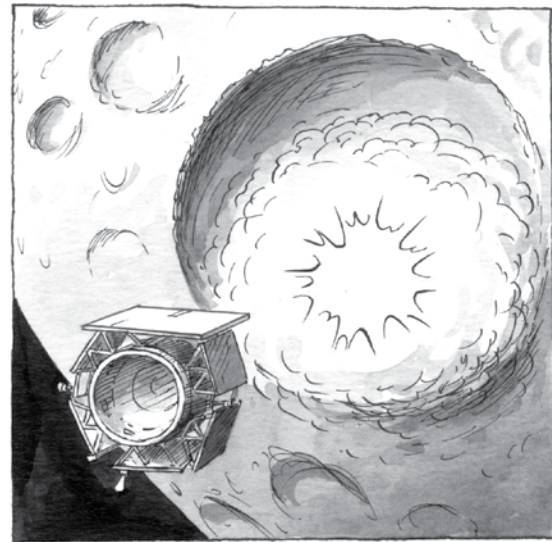
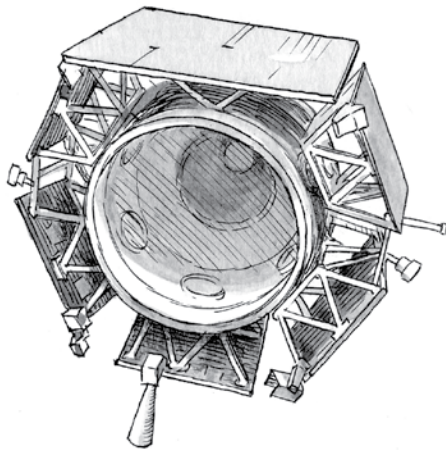

LOOK OUT BELOW!

NASA wants to make a deep hole on the moon to see if there's ice in the soil. But instead of beginning to dig at the surface, NASA is getting a head start. It will dig its hole at the bottom of a crater that's already about one mile (2 km) deep—and it won't dig, exactly. Instead, NASA will plunge a spacecraft named LCROSS into the crater. Scientists expect the collision will make a hole that's 80 ft. (24.4 m) across and 15 ft. (4.6 m) deep. The chances of finding ice at the bottom of this deep, dark, cold place are much better than finding it at the moon's surface, where the sun shines brightly on the soil, vaporizing any ice.

Watch **DESIGN SQUAD** on PBS or online at pbs.org/designsquad.



Major funding for *Design Squad* provided by



A private corporation funded by the American people



Education

Additional funding for *Design Squad* provided by



Design Squad is produced by WGBH Boston. *Design Squad*, AS BUILT ON TV, and associated logos are trademarks of WGBH. All rights reserved. This NASA/*Design Squad* challenge was produced through the support of the National Aeronautics and Space Administration (NASA).



For more information about NASA missions and educational programs, visit nasa.gov.